

# Quetsol S.A.

**Ben Dana**

**2012**

(Nueva  
Libertad  
Community,  
Huehue-  
tenango,  
Guatemala.)



## **Small Scale Offgrid Solar PV: Installation Manual**

A complete installation guide for Solar PV systems up to 235W (or one solar panel.) Written in collaboration with Quetsol, primarily for applications in Guatemala.



## Contents

Glossary.....	3
Tools.....	4
Material.....	4
Summary .....	5
A. Solar Panel. ....	5
B. Accommodate the Battery, Regulator and Inverter. ....	5
C. Lighting Circuit .....	5
D. Comissioning. ....	6
General Installation Requirements .....	6
A. Solar Panel .....	7
1. Test Voc with a multi-meter/ electrical tester.....	7
2. Choose a spot for the panel.....	7
2.1 Optimal Inclination for the Solar Panel.....	8
3. Fixing the Solar Panel to the Roof.....	8
3.1 Fixing the Panel to a flat roof.....	11
6. Installing the Solar Cable.....	13
6.1 Splices in the Solar Cable .....	14
B. Installing the Battery, Regulator and Inverter. ....	16
1. Choose a place for the battery.....	16
2. Mount the Regulator and Inverter on the wall.....	16
3. Prepare the cables between the Battery and the Charge Controller. ....	17
4. Prepare the Inverter cables .....	17
5. Connect the cables to the Battery .....	18
5.1 Terminals for connecting multiple cables to the battery. ....	19
6. Connect the cables from the battery to the regulator .....	20
C. Lighting Circuit (12Vdc).....	21
1. Install the main DC distribution line. ....	21
2. Prepare the light bulb sockets. ....	21
3. Install the bulb sockets and connect to the negative distribution line.....	22
4. Install the switches.....	24
D. Comissioning .....	25



## Small Scale Offgrid Solar PV: Installation Manual

1. Connect the cables from the Panel to the Regulator .....	25
2. Connect the DC lighting circuit to the charge controller. ....	25
3. Client hand over .....	25
Appendix 1: Electrical Connections.....	25
A1.1 Simple wire splicing .....	25
A1.2 Crimped joints.....	26
A1.3 Joints with connector blocks. ....	28
Appendix 2: Optimal Tilt Angle for a solar panel in Guatemala.....	29
Appendix 3: Installations with more than one battery .....	29
Reference .....	31

## Glossary

**AC Alternating Current:** Electrical current in which the magnitude and the direction vary cyclically. Commonly used, A.C. refers to the form in which electricity is supplied to homes and businesses compatible with most appliances (110 V at 60 Hz.)

**Solar Array:** 2 or more Solar Panels connected together

**Battery Capacity (Amp-Hours, Ah):** The value of a battery. The required capacity is calculated according to the energy needed for electrical loads and the number of autonomy days.

**DC Lighting Circuit:** 12V DC bulbs together with their bulb sockets, switches and cabling. This circuit is connected to the Charge Controller for automatic disconnection if the battery is discharged. Low energy bulbs are recommended (>10W.) DC Current always maintains the same polarity, meaning it's important that the bulb socket connections are correct.

**DC Direct Current:** Electrical Current across a conductor between two points of different potential. In contrast to Alternating Current (A.C.) the electrical charge always flows in the same direction (in other words the terminals of greater and lesser potential are always the same.) This means that the positions of the Positive and Negative are very important. The energy generated by a solar panel and stored by a battery is normally Direct Current (DC).

**Inverter:** Device which converts D.C. input voltage to A.C. output. An Inverter in Guatemala will change the Direct Current of a battery (normally 12V) to 110V; for use in the majority of common electrical appliances.)



## Small Scale Offgrid Solar PV: Installation Manual

**Offgrid Solar Energy:** Electrical generation with Solar Panels without connection to the electrical grid. This needs at least one battery so that the energy can be used when there is no sun. This Manual is relevant to installations of one single solar panel, or lower than 235W.

**Isc Short-Circuit Current:** The short-circuit current is the current across a solar cell when the voltage is zero (or when the solar cell is in short-circuit.) Published in the technical data on the underside of a panel, it's one of the main parameters of a Solar Module. Normally it's quoted under Standard Test Conditions ('STC'); 1000 W/m solar irradiation; 25 °C cell temperature.

**Solar Panel:** A module that makes use of energy from solar irradiation. This guides refers to Photovoltaic Panels to generate electricity

**Regulator (Charge Controller):** This balances the voltage of the Solar Panel, Battery and DC Circuits, and monitors the State of Charge (SOC) of the battery. It protects the battery from overcharging by the panel, and disconnects DC loads when voltage is low to prevent over-discharge.

**MC4 Terminals:** Connecters for the DC solar cable. In general they are the industry standard.

**V<sub>oc</sub> Open Circuit Voltage:** Difference in Electrical Potential between two terminals of a device when no external charge is connected. Under these conditions there is no external electrical current between the terminals. Voc of a solar panel should be published in the technical plaque on its underside. It is quoted according to Standard Test Conditions ('STC'.)

## Tools

Compass; Volt-meter; Pliers; Ratchet crimping tool; Hammer; Screw-drivers; Fixed Spanners; Wire Cutters; Spirit level; Tape measure; Marker pen; Stanley knife; Battery drill (with two charged batteries); Hacksaw; drill bits including a 3/8" socket bit and a screw-driver bit; ladder.

## Material

*The success of the installation depends on arriving prepared with the right kit.*

Solar Panel; Charge Controller; Inverter; Battery

Cable for different parts of the installation; Cable clips; MC4 Connectors (Solar Cable)

Hexagonal roof screws - 3 ½" and other sizes; 4" nails

Threaded hexagonal bolts - 5/16 x 11/2". 5/16" nuts and washers. Silicone.

Angle aluminium 50mm x 50mm x 2.5mm (3m.) Wooden board (around 30cm x 3cm x 160cm.)

Crimp connectors (for batteries); Crimp connectors (for splicing); Light bulb sockets; Switches;

Energy saving 12V bulbs

Self tapping screws; wall plugs; Cable ties; Red and black electrical tape.



## Summary

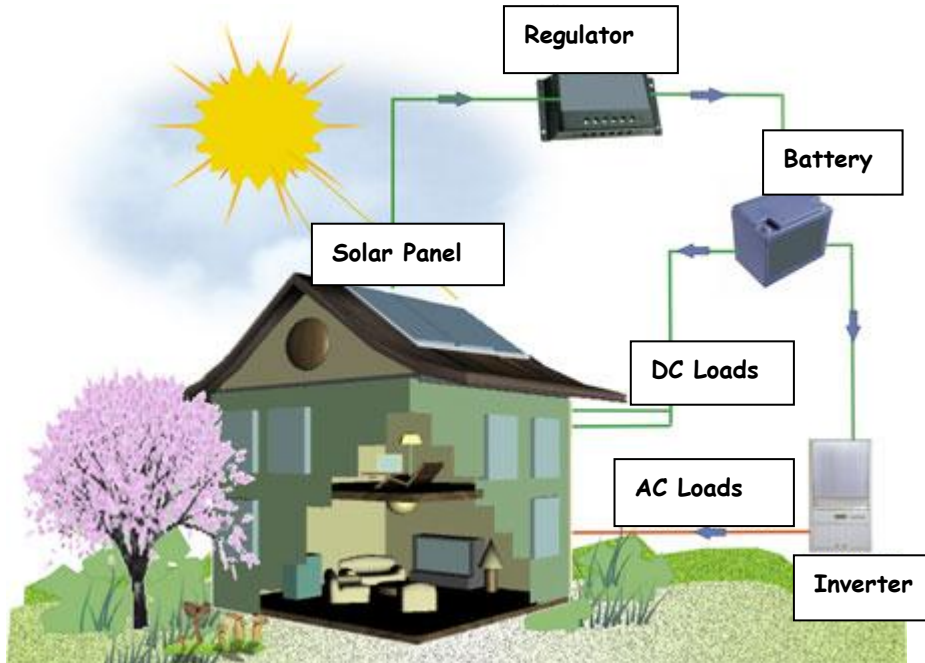

The Installation can be divided into 4 different parts:

### A. Solar Panel.

- Choose position and fix the solar panel to the roof.
- Connect the cable to the solar panel.
- Install the cable between the Panel and the Regulator.

### B. Accommodate the Battery, Regulator and Inverter.

- Choose a place for the battery.
- Fix the Regulator and Inverter to the wall or a board.
- Prepare the cables between the battery and the regulator.
- Prepare the inverter cables
- Carry out the connections to the battery.
- Connect the battery cables to the Regulator

### C. Lighting Circuit

- Install the main DC Lighting cables.
- Prepare the bulb sockets.
- Fix the lamp holders to the ceiling and connect to the main lighting cable.
- Install switches.



## Small Scale Offgrid Solar PV: Installation Manual

### D. Comissioning.

- Connect the Solar Panel cables to the charge controller.
- Connect the DC load circuit to the charge controller.
- Handover the system to the client.

### General Installation Requirements

It's important that the cables and equipment are made to look neat. Horizontal and vertical cables should be straight and kept out of sight above beams etc. Where cables run the same way it's preferable to install them together.

Cable splices should be meticulously carried out to minimise risk of short circuits. They should be completely covered with insulation tape.

All cables should be mechanically supported to a high standard. It's better if they are run via the highest possible path in order to be out of reach. Cables should be clipped at least every meter. Be very careful when installing the clips to avoid scratching/ puncturing the cable.

Take great care to respect polarity throughout the whole installation. Twin cable in Guatemala usually has white insulation for both conductors. Quetsol's policy is to use the corrugated side as the positive. This means that the negative conductor is the cable with smooth insulation, sometimes printed with text.



If the cable has two colours, then white is used as the positive and black as the negative. It's preferable to mark the polarity of splices with insulation tape (red for the positive cable and black for the negative.) The 6 cables connected to the Regulator should also be labelled with a ring of insulation tape, and the points of connection to the battery (at least the positives.)

#### Labelling polarity





## Small Scale Offgrid Solar PV: Installation Manual

Avoid working on live cables, to reduce the possibility of a short circuit. For this and other reasons, it's preferable to connect the DC lighting circuit to the Regulator when the other parts of the installation are completed.

### A. Solar Panel

#### 1. Test Voc with a multi-meter/ electrical tester

Expose the panel to sunlight. Make sure that Tester's the dial and the electrical leads are in the right position for measuring DC voltage.



Make contact between the Solar Panel's cables and the Tester's conductors. Note down the voltage. It should be within a range of variation from the VOC printed on the back of the panel (the variation depends on the solar irradiation at that moment.)

#### 2. Choose a spot for the panel

It's essential that the Panel is facing as close as possible to 0° south (in the Northern hemisphere; South of the Equator the Panel should face North.) Use a good quality compass to determine which side of the roof faces south.





This side of the building faces south (white arrow); deviation around 25° .



However, it's more important that there's no object in front of the Panel that could affect its performance with shading, such as buildings, trees or topography.

The shade of an object depends on its height, general shape and position in relation to the Panel; so it's difficult to predict without a calculation using the exact measurements. But if there's a possibility that the shade could affect the Panel's performance (if the object is higher than the Panel), it's better that it is positioned elsewhere. If it's necessary to choose, it's better for the panel faces west or east, if it would be affected by shading facing south.

## 2.1 Optimal Inclination for the Solar Panel

Appendix 2 has more information on this. However, the inclination of the Panel is usually determined by the roof pitch.

The optimum angle to generate maximum solar gain is a function of latitude, but also the use and efficiency of the solar system over the course of the year

**Latitude** in Guatemala is 14° (37' 15" N)

**Optimal tilt for summer use** = angle of latitude - 20° → 5° For a water pump for example

**Optimal tilt for winter use** = angle of latitude + 20° → 35°. For example, an offgrid solar system with year-round demand, including winter

Optimum tilt for maximum total generation during the year is equal to angle of latitude → 15° .

For a grid connected installation, for example.

## 3. Fixing the Solar Panel to the Roof



Always take great care on the roof to avoid accidents. Remember that the rain makes a galvanized metal roof very slippery. You should use boards to spread your weight over the roof sheets. Only step where there is an interior beam below (indicated by a line of screws.)





## Small Scale Offgrid Solar PV: Installation Manual

These steps explain how to fix a Solar Panel to a corrugated metal sheet type roof using aluminium angles.



Cut the two lengths of aluminium angle at (solar panel width + 20 cm); leaving a 10cm overhang on either side of the Panel.

Fix one length of aluminium to each end of the panel.

1. Position the first length of aluminium at the edge of the panel to mark the positions of screws. The horizontal part of the angle should be facing away from the panel, not positioned underneath it.



2. The screws should be positioned so that the heads, on the inside of the frame, do not scratch the underside of the panel. A scratch could ruin the panel. Also make sure the length of aluminium is flush with the panel frame.
3. Drill the aluminium with a drill bit 1mm larger than the screw (7mm in this case.).
4. You can mark the second angle according to the holes positions in the first.
5. Hold the aluminium to the edges of the panel again to mark the position of the holes in the frame before drilling.



## Small Scale Offgrid Solar PV: Installation Manual

6. Use threaded hexagonal screws,  $5/16 \times 1 \frac{1}{2}$ ". Hold the screw head with pliers inside the frame as you tighten the nut with a spanner.



At this point it's better to carry out whatever work is necessary to extend the solar panel's cables, before the solar panel is permanently fixed to the roof. This is explained in Section 6.

### Fix the solar panel to the roof

1. Position the lower aluminium angle above an interior roof beam. The roof screws can be used as a guide.

Although this panel is anchored with a plank, the photo shows the plank positioned above a roof beam



The roof screws serve as a guide.

2. Mark two holes in the horizontal angle so that they are above the upper profile of the sheet. This minimizes the ingress of rain. The fixing is done with hexagonal roof screws. Drill the aluminium with a  $3/16$ " drill bit.



3. You can now fix to the beam using  $3 \frac{1}{2}$ " roof screws. Use the battery drill with a  $3/8$ " socket bit. If the screw slides on the corrugated roof sheet instead of going through, drill a hole in it first, with a  $3/16$ " drill bit for metal. If you drill holes that are not used make sure to seal them with silicone.

If the building has metal beams, use long bolts, fastening the nut on the inside of the beam. One installer on the roof clamps the bolt head, while another installer in the attic tightens the nut. A ladder will be needed on the inside.



## Small Scale Offgrid Solar PV: Installation Manual

Fixing the upper part of the panel to the roof is more complicated. There will not be a beam directly beneath it to fasten to.

4. The installer in the attic positions a wooden board directly below the upper edge of the panel. The board should be the width of the panel + 60 cm, with an equal overhang on each side. This person has to push the board up against the inside of the roof, while the installer on the roof screws through with  $3\frac{1}{2}$  " roof screws to hold it in place.

**Support board on the inside of the roof for fixing the upper part of the solar panel.**



5. The upper aluminium angle can now be screwed to this board (see step 3). It's easier to achieve a good fixing if the person on the inside carries on pushing upwards. If the roof screws are not long enough use 4" nails.

### 3.1 Fixing the Panel to a flat roof

On a Central American flat roof you can use the building's structural steel (rebar) as a base for installing the Panel. In this example, wooden boards are used as the panel supports rather than aluminium angle.





## Small Scale Offgrid Solar PV: Installation Manual

The first job is to pass the rebar through a thick board so that it sits on the perimeter wall. Position the holes in the board carefully so that they marry up with the rebar. It should be held in place with rebar at each end. Bend the rebar horizontally above the board.



### *How to fix the support board to the solar panel.*

Choose a board that measures 40cm x (width of the panel + 60cm), in a fit state to withstand the elements. With the glass face down, centre the board above the upper part of the frame. Fix it in place with 4 hexagonal roof screws (1½" but check according to the board thickness.) Use the battery drill with a 3/8" socket bit.

The board has to be flush with the surface of the panel's frame, but it's important that the points of the screws do not touch the underside of the panel. This part is very delicate and a scratch could ruin the panel. First check that the screws are the right length for the panel (as the frame thickness varies.) It's better to sink the heads into the board a little with a thick drill bit, to allow it to sit flat.

**Support board fixed to the panel's underside**

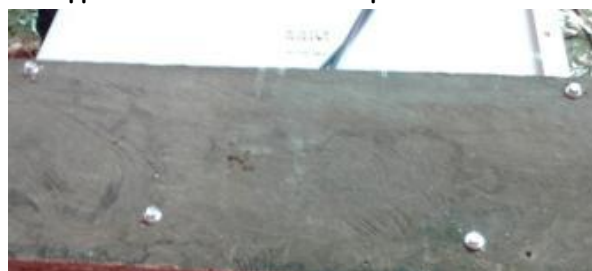

The Panel can now be positioned according to the desired angle of inclination. Then the support board can be screwed down to the first board. Use screws that are long enough to ensure plenty of thread in the first board, and make sure there is good contact between the two wooden surfaces.





For extra support, use wire between the rebar and the holes in the panel frame.

### 6. Installing the Solar Cable

To avoid piercing the roof, the cable passes through to the inside of the house underneath the crest of the roof. The best way to do this is to lead with a cable guide from the inside and tie it to the end of the cable on the roof.



The splices/ connections in the solar cable should be tucked underneath the board to protect them from the weather.





## 6.1 Splices in the Solar Cable



*It's better to splice/ extend the solar cable before the Panel is fixed down on the roof.*

*Chose the cable gauge according to the Quetsol technical guide: [Cable Selection in small Off Grid Solar Energy Installations](#). Make sure it's long enough to reach the Charge Controller.*

It's best to make the connection with MC4 terminals as the Solar Panel cables come with these connectors. It's the best way to minimize the possibility of water ingress and to reduce voltage drop. Alternatively, a cable join using crimp terminals offers better mechanical strength and less voltage drop than simply splicing the wires (Appendix A1.2.).



Afterwards this cable can be run to the area planned for the Charge Controller (leave it long until the Controller is in place.)



*Once connected to the solar panel, the positive and negative cables should never be in contact. Therefore, when the distance to the charge controller has been determined, it's advisable to cut one cable and then the other, rather than the two together.*

**Seperate cuts in twin cable with exterior insulation e.g. cable TSJ2).**

**Cut the exterior insulation all the way around (without scratching the cables.)**





### Small Scale Offgrid Solar PV: Installation Manual

Twist the exterior cover on each side of the cut, pulling to separate. Cut points that are still joined.



When the cables are exposed, cut them individually and tape up the ends

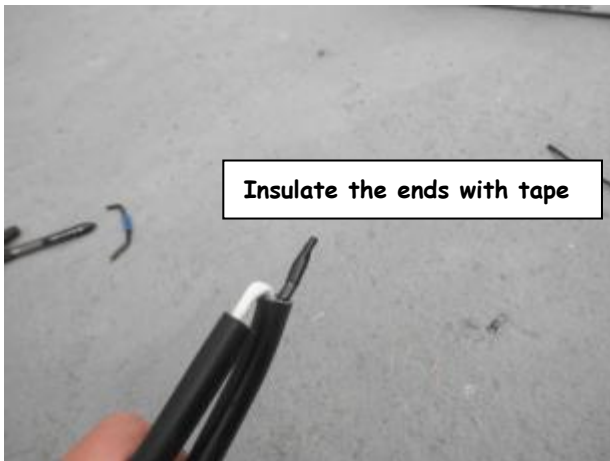

The cable will often pass by the edge of a roof sheet where it comes into the house. It's better to protect the area of contact to prevent damage in the wind.



Cable protected from the roofing sheet edge with insulating tape or a plastic bottle.



## B. Installing the Battery, Regulator and Inverter.

### 1. Choose a place for the battery

The battery should be placed where there is a minimal possibility for contact with fire, water or other hazards. It has to be under a roof with no leaks and not in the kitchen. It shouldn't get in the way of the people in the house. It should be accommodated on a table, as on the floor it can be knocked over easily and more cabling will be needed.

### 2. Mount the Regulator and Inverter on the wall.

The Regulator and the Inverter are screwed to the wall above the battery. It's preferable that the Regulator is out of the reach of children. This is also the case for the Inverter, but before mounting to the wall, ensure that its cables will reach the battery. Possibly the inverter will have to be installed upside down for this reason.

- Mounting on a wall of planks: Screw directly using 'self-tapping screws'.
- Mounting on a cinder block wall. It's better to mount a small board first.



The best way to fix to blocks or bricks is with screws and wall plugs:

- Make holes in the board, making sure that the holes will give it a level position.



## Small Scale Offgrid Solar PV: Installation Manual

- Mark the position of these holes in the wall behind and drill the wall (with hammer-drill.) Drill into the wall as far as you need for the wall plug.
- Put the wall plugs in, with a hammer if needed.
- Screw to the wall, with screws long enough to pass through the board and fill the whole plug.

Alternatively in Guatemala the blocks are usually soft enough for nails. Ensure there is enough space on the board between the nails for the Regulator and the Inverter.

- Mounting in Adobe wall. Self-tapping screws normally achieve a good fixing in adobe (meaning the Inverter and Regulator can be mounted with no board.) It's important to start with the Regulator flush to the wall (on a part of the wall that's level.)

### 3. Prepare the cables between the Battery and the Charge Controller.

Chose the cable gauge according to the Quetsol technical guide: [Cable Selection in small Off grid Solar Energy Installations.](#)

Measure the amount of cable needed for the cable run to look neat, including changes in direction. Prepare the ends to connect to the battery :

- Remove enough exterior insulation (of TSJ cable) for the wires reach the two poles of the battery.
- Prepare the ends with crimped terminals for battery connection.
- Mark cable polarity with black and red insulation tape at the ends.

Clip the cable to the wall.

### 4. Prepare the Inverter cables

Inverters for offgrid solar often come supplied with the battery connection cables. This Manual explains the steps for connection with crimp terminals. Make sure to buy terminals that are large enough for the threaded connection points on the battery, and to fit the cable gauge.

Remove the crocodile clips for battery connection. They present a risk of inverse connection.

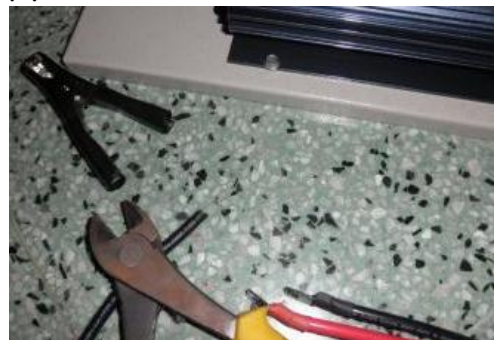



## Small Scale Offgrid Solar PV: Installation Manual

With the first cable, measure how much insulation it's necessary to remove for the cable to enter to the end of the terminal and strip it. Twist the cable strands together.



When positioning the terminal on the end of the cable, make sure that no strands stick out. The inverter cable is very thick, so a few strands can be cut if necessary. The end of the cable should reach the end of the tube and there shouldn't be bare cable on the entry to the terminal.

Place the terminal + cable in the teeth of the crimping tool. Make sure it is positioned to crimp the interior metal tube (not just the exterior insulation.) Pull the terminal to ensure the crimp is strong.



Wrap the edge of the terminal and the cable with insulating tape (black negative and red positive.)

Repeat the whole process with the other cable. Clip the cable to the wall in its path to the inverter. The other end of the cables can now be connected to the Inverter (it usually comes supplied with terminals for this purpose.)



### 5. Connect the cables to the Battery

The Inverter and the Regulator cables are ready to be connected to the threaded battery terminals. The positive and negative cables are connected together.

Positive and Negative cables connected to the battery together.



Completely tighten the screws on the battery with a fixed spanner to ensure good connections.



*Take care with the ends of cables between the Battery and the Regulator; they are now live. The negative and positive should never come into contact. If you haven't connected to the Inverter yet, this is also the case with the Inverter cables. When tightening connections to the battery, always make sure that the metallic tool never touches the opposite pole.*

### 5.1 Terminals for connecting multiple cables to the battery.

The quality of connection to the battery is important to reduce voltage drop and the risk of over-heating. Crimp connectors are preferable, but some installers use these screw terminals. In any case, to use the terminals it's better to prepare the cables with the same crimp connectors, instead of merely twisting the bare wire.



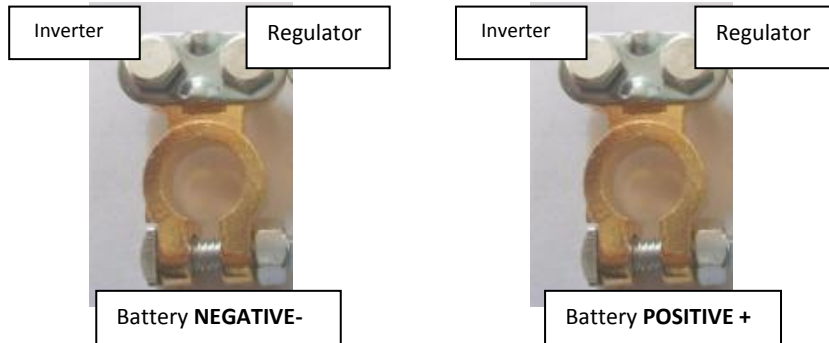

First prepare the positive terminal with its Regulator and Inverter cables. Then prepare the negative terminal in the same way. To attach each terminal to the lead point of connection on the battery, it can be opened with pliers and then forced down with a hammer. Tighten completely with a fixed spanner or socket.

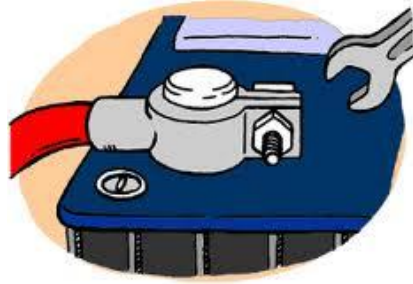

### 6. Connect the cables from the battery to the regulator

Following the indications on the Regulator which nominate them 1, 2; the inlets from the battery should be connected first. This is to balance the system voltage according to the battery. Once this is carried out the LEDs (green, orange and red) should come on one after the other, finishing with the constant illumination of the orange LED (on the *Morningstar SHS* Regulators.)

Order of Regulator connections (Morningstar diagram.)

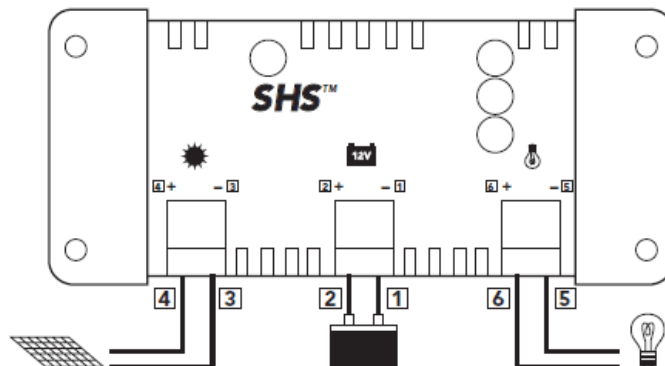

For connections to the Regulator:

- User the right size screw driver.
- First slacken the terminal screws completely



## Small Scale Offgrid Solar PV: Installation Manual

- Ensure that no cable strands are left outside the terminals
- Completely tighten the terminal screws.

### C. Lighting Circuit (12Vdc).

#### 1. Install the main DC distribution line.

Once the client has specified where s/he wants the lights in or outside the house, the main cable between the Regulator and the bulbs can be installed.

Choose the cable section according to the Quetsol Technical guide: [Cable Selection in small Offgrid Solar Energy Installations](#)

#### 2. Prepare the light bulb sockets.

The DC bulbs supplied by Quetsol have their positive connection in the middle of the threading, with the negative contact on the side.



As a result the polarity of the bulb socket has to be:

- Positive - middle connection
- Negative - side connection

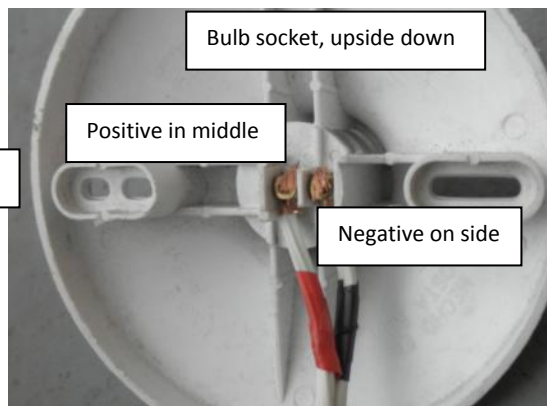
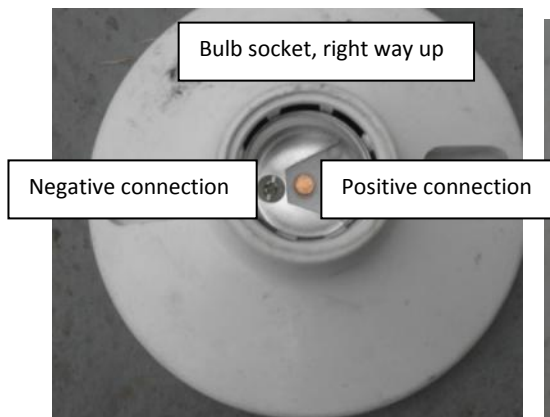



## Small Scale Offgrid Solar PV: Installation Manual

To switch off the bulb the switch disconnects the positive line in the circuit. Therefore every bulb socket has to be prepared with:

- Switch cable - middle connection terminal (the other cable from the switch is connected to the Positive of the DC Distribution line.)
- Cable connected to the Negative of the DC distribution line - connection terminal on the side.

These cables need to comply with the Quetsol Technical guide: [Cable Selection in small Offgrid Solar Energy Installations](#)

Obviously it will be necessary to first verify the distance to the position of the switch to avoid connecting a wire that's too short to the bulb socket. It's better to minimise cable splices in the whole installation; each cable joint increases the total load on the battery.

### 3. Install the bulb sockets and connect to the negative distribution line.

The bulb socket has holes so that it can be screwed to a beam. To install it to a concrete roof wall-plugs and screws will be necessary. Ensure the cables aren't caught behind its edge during installation. If necessary cut out a small cable channel with pliers

For connections to the main Distribution line it's preferable to join to the continuous wire without cutting it (rather than splicing the ends.) The steps are explained below.

#### How to connect to a cable without cutting it (twin 2-core cable.)

Separate the 2 wires with 2 pliers without damaging the insulation. Allow enough room for the insulation tape to pass through.



**Cut the insulation of one cable all the way round (without damaging the copper.)**

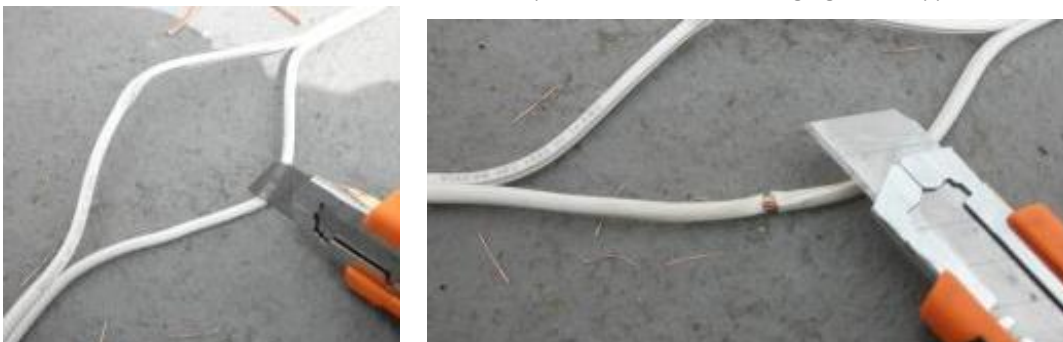



Repeat at a 2cm distance from the first cut. Remove the insulation with a horizontal cut.

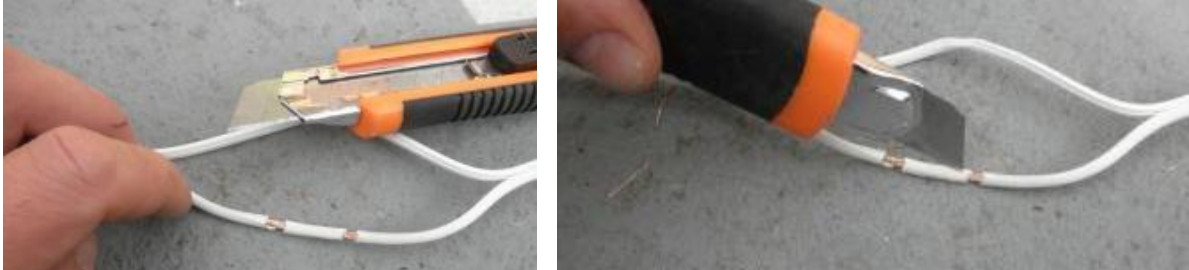

Remove 1" of the insulation from the cut end of the cable to be connected. Divide in 2 and twist the strands to the two parts together. Position the first cable between them.

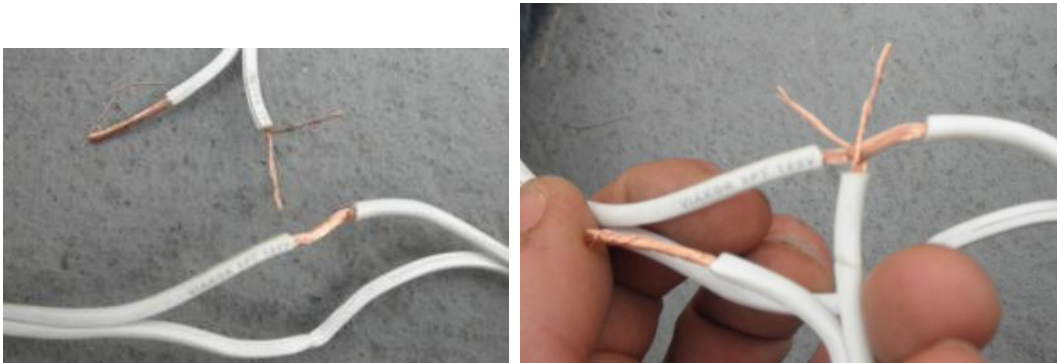

Wind one part round the first cable towards the right, ensuring tightness. Repeat with the other part in the other direction.

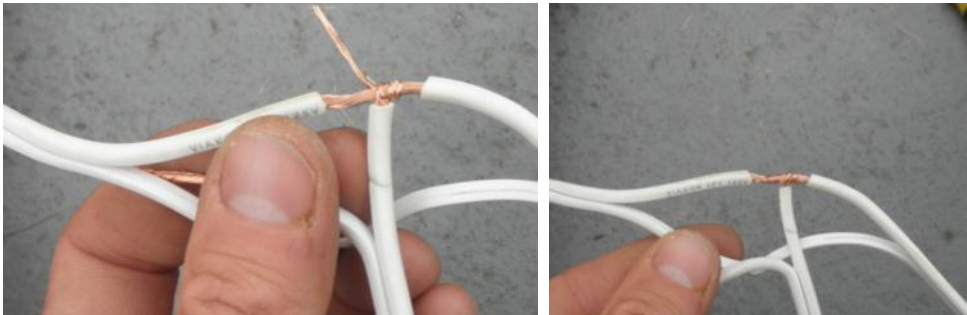

Protect the joint with insulating tape (positive with red tape and negative with black tape.)

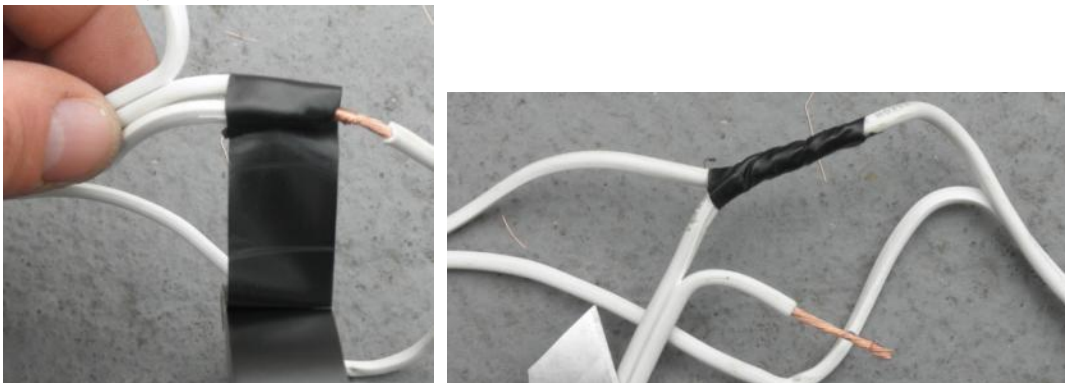

Screw the bulbs into their holders.

#### 4. Install the switches.

Switches are sometimes available in two types. The switches in the photos below are not designed to screw to the wall. In general they are installed with their cable hanging in the air below the bulb socket.



The others have holes on their backing so that they can be screwed to the wall. Normally they are installed in the entrance of the room and the cable is clipped to the wall.

Switch connection



Even though they need more cable it's preferable to use the wall mounted switches because supporting the cables improves the mechanical resistance of the electrical installation. This reduces the risk that a hanging cable could be pulled out one day, possibly damaging the installation. The people of the house should be consulted about switch positions.

Firstly make sure that your cable is long enough between the switch, the main Distribution line and the bulb socket. It's important to have as few cable splices as possible. The interior



## Small Scale Offgrid Solar PV: Installation Manual

connection screws need to be well tightened, making proper contact with their wires. The switches which are not for wall mounting are harder to close with their outside cover.

### D. Commissioning

#### 1. Connect the cables from the Panel to the Regulator

Once the cables have been clipped to the Charge Controller you can make the connection. Below the terminals mark the positive cable with red tape (as explained in B6).

When the panel is connected to a Morningstar SHS Regulator, a green LED should light up on the left. The State of Charge LEDs should change from orange to green (showing that the battery is well charged.)

#### 2. Connect the DC lighting circuit to the charge controller.

Label polarity below the terminals. Screw in the light bulbs and ensure each one turns on.

#### 3. Client hand over

Ensure that the people of the house understand how the system works and how to maintain it. They should be left with a *System User Manual* showing this information.

## Appendix 1: Electrical Connections.

### A1.1 Simple wire splicing

Remove 1" of insulation from the cut end of each cable. Twist the strands of the first cable together. Separate the second cable into two parts, ensuring the strands of each part are well twisted together.

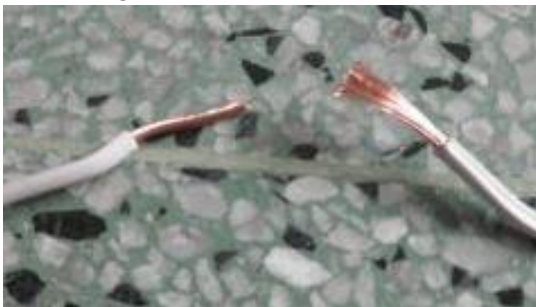



## Small Scale Offgrid Solar PV: Installation Manual

Position the first cable between the two parts of the other. Wrap one part around the first cable, moving downwards and ensuring tight contact.

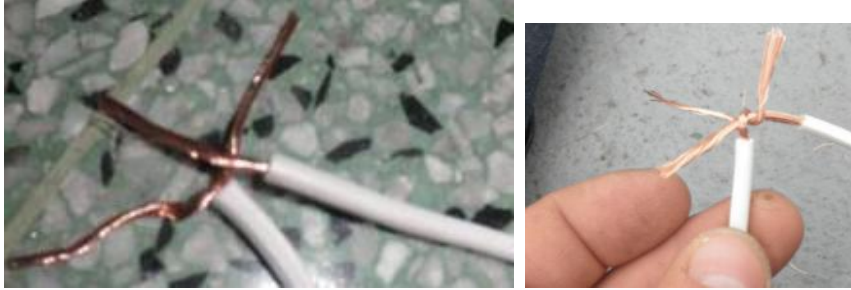

Push the union downwards. Wrap the other part around in the other direction.

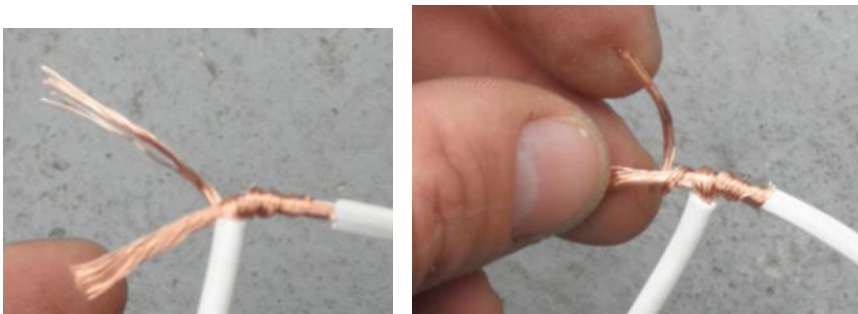

Bend the end of the splice downwards



Wrap up with insulation tape



### A1.2 Crimped joints

Crimp terminals are usually available in Celasa, Guatemala





## Small Scale Offgrid Solar PV: Installation Manual

Measure and strip the insulation required for the cable to enter up to the midpoint of the terminal. Twist the strands together. Repeat with the second cable.



When positioning the terminal ensure that no strands are outside the interior metal tube. The end of the cable should be halfway down, but stripped cable should not be visible on where it goes into the terminal.



Push the other cable into the other side of the terminal in the same way. Position the terminal in the jaws of the crimping tool. It should be positioned so that the metal tube is crimped (not just the exterior insulation) but without squashing the part of the terminal for the other cable.



Fully close the crimping tool. On opening it the terminal and the cable are squashed together. Make sure it's strong by pulling it.



Crimp the second cable in the other half. Protect the joint with insulating tape.



### A1.3 Joints with connector blocks.

Connector blocks are available from various electrical suppliers in Guatemala. Avoid buying dubious quality connectors; some cause problems when tightening the screws. If the terminal is big enough for two wires to fit in the same side this is preferable.

#### *With both cables going into the same side of the terminal block.*

1. With the first cable, measure how much insulation it's necessary to remove for the cable to enter to the end of the terminal and strip it. Twist the strands together. Repeat with the second cable.

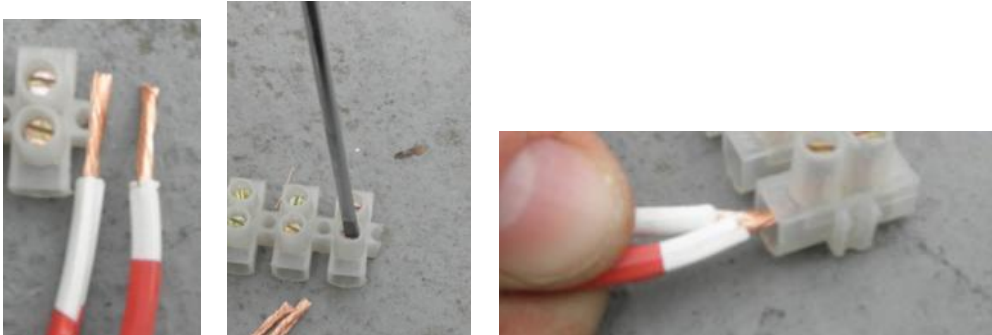

2. Completely slacken the terminal screws. Twist the cables together. When positioning the terminal on the end of the cable, make sure that no strands stick out of the interior metal tube. The end of the cable should reach the end of the metal tube, and there shouldn't be bare cable on the entry to the terminal.
3. Completely tighten the terminal screws. Make sure it's strong by pulling. Protect with tape.

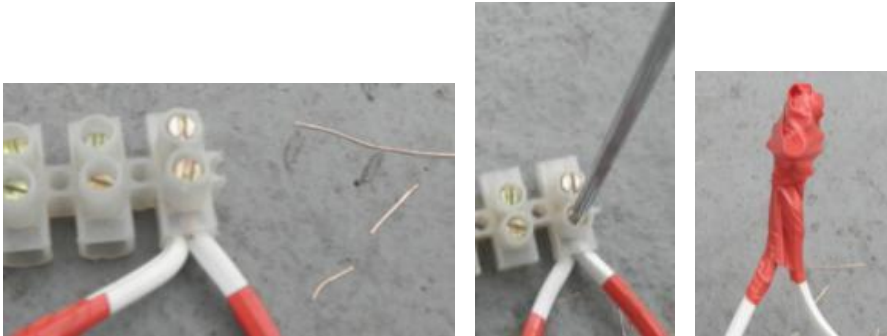

If the two wires are too thick to fit in together, connect with one each side of the terminal block





## Appendix 2: Optimal Tilt Angle for a solar panel in Guatemala.

The optimal tilt angle for maximum solar gain is a function of latitude but also the use and efficiency of the solar system during the year. A panel with a steeper tilt be exposed to more solar irradiation in winter months when the sun is lower; although the average solar irradiation / m<sup>2</sup>/day would be higher if the tilt were the same as latitude. **Latitude** in Guatemala is 14° (37' 15" N.)

A solar pumping system, for example, would require a tilt angle for maximum solar gain during summer months; to cope with the heaviest demand for pumping. Optimal tilt for summer months = **(angle of latitude - 20°) → 5°**

For year round electrical load, an offgrid solar system should be installed in a way that captures maximum solar irradiation during winter; the months when it's most difficult to keep the battery charged. In Ecuador and other tropical countries with consistent solar irradiation through the year, the tilt angle can be the same as latitude. However, in temperate zones of Guatemala the optimal tilt = **(angle of latitude + 20°) → 35°**.

**Optimal tilt angle for maximum total generation during the whole year is the same as latitude → 15 °.** For example a grid connected solar energy installation.

## Appendix 3: Installations with more than one battery



Small installations with just one solar panel normally need just one battery. Nevertheless for 100 - 235W installations it's possible that two batteries will be needed to achieve the required voltage and capacity. Sometimes just one battery at the necessary voltage and capacity will be more expensive than combining two weaker batteries. The voltage of a group of batteries = (number of batteries connected together in series) x voltage of one battery. The capacity of the group = (number of batteries connected together in parallel) x capacity of one battery. Never mix different types of battery.

This table recommends the battery configuration for different solar panels between 100W and 235W. With no consumption profile for design, optimal capacity is based on the panel's daily generation in Guatemala (assuming 4.5 Peak Sun Hours); with 2 autonomy days and 50% Depth of





### Small Scale Offgrid Solar PV: Installation Manual

Discharge. The capacity of the batteries selected is slightly less than the optimal to minimize costs. There are two options for the 100W solar panel. The option of two 90Ah batteries provides an example of configuration in parallel.

Solar Panel	Estimated optimal battery capacity	Batteries selected	Total Capacity and voltage
100W, 12V	188Ah	(Surette Rolls 27 HT 90 [12V, 90Ah] x 2 in parallel) • (1 x Trojan T175 [12V, 150Ah])	(180Ah, 12V) • (150Ah, 12V)
150W, 12V	280Ah	Trojan T145 [6V, 260Ah] x 2 in series	260Ah, 12V
150W, 24V	140Ah	Trojan SCS225 [12V, 130Ah] x 2 in series	130Ah, 24V
180W, 24V	170Ah	Trojan T1275[12V, 150Ah] x 2 in series	150Ah, 24V
235W, 30V	225Ah	Victor 12V, 200Ah x 2 in series	200Ah, 24V

#### Batteries connected in parallel

*Voltage stays the same. Capacity increases*

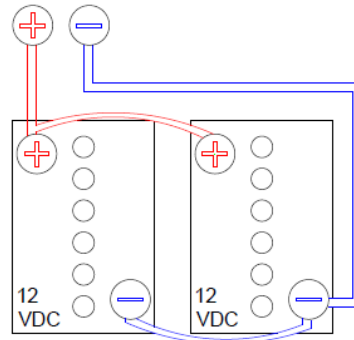

Example: 2 x Surette Rolls 27 HT 901(12V, 90Ah.)  
For one 100W solar panel, 12V  
Total Capacity and Voltage:180Ah, 12V

#### Batteries connected in series

*Voltage increases. Capacity stays the same*

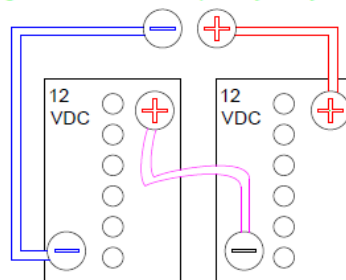

Example: 2 x Victor 12V 200Ah.For 1 235W,  
30V panel. Total battery capacity and voltage:  
200Ah, 24V



**Rules for safe battery installation.**

- Use thick cable for link connections between the batteries (#2 AWG gauge.)
- The terminals for these links must be very well done, with no bare cable visible.
- Tighten the screws of the battery terminals according to the torque recommended by manufacturers.
- The main positive and negative cables should be the same length and should be connected to opposite sides of the bank of batteries. This is to create an equal path length for the flow of electrons.
- Draw a diagram of the connections.
- Never mix batteries of different types
- Never measure battery current across terminals
- Use the right size fuse if it is necessary to have a fuse. It should be installed in main positive battery cable.
- Remove jewellery before starting work.
- Use the right tools. It's better to work with insulated tools.
- Disconnect any battery charger or electrical load before working
- Use goggles to protect your eyes and wash your hands immediately after working.

**Reference**

Fotovoltaica: Manual de Diseño y Instalación. Solar Energy International, 2007